

Mini

- ... reduces setting-up times.
- ... gives rapid and precise mounting.
- ... is suitable for automatic changing with System 3R's automation program.

Mini

The ancestor of the reference systems! The introduction of the Mini system in the early 1970s created the basis for efficient electrode production and spark-erosion machining. Electrodes could now be produced mounted on inexpensive holders. Subsequent alignment of the electrodes in the spark-erosion machine was eliminated. The Mini system introduced the precision and flexibility that had until then been absent from spark erosion technology.

The Mini system provides rapid and exact mounting of the electrode holders in hydraulic quick-change chucks. This high change accuracy is achieved thanks to the two chambers of the hydraulic system, which expand uniformly and provide symmetrical locking against the fixed Z reference with angular location.

The Mini system is a "Reverse Reference System", in which the chuck adapts itself to the electrode holder, which is why all electrode holders must be exactly alike – in diameter, roundness, straightness and hardness – to meet the accuracy requirements.

Even today, the Mini system is probably the most widespread reference system in the world.

+ Clamping force – 4000 N.

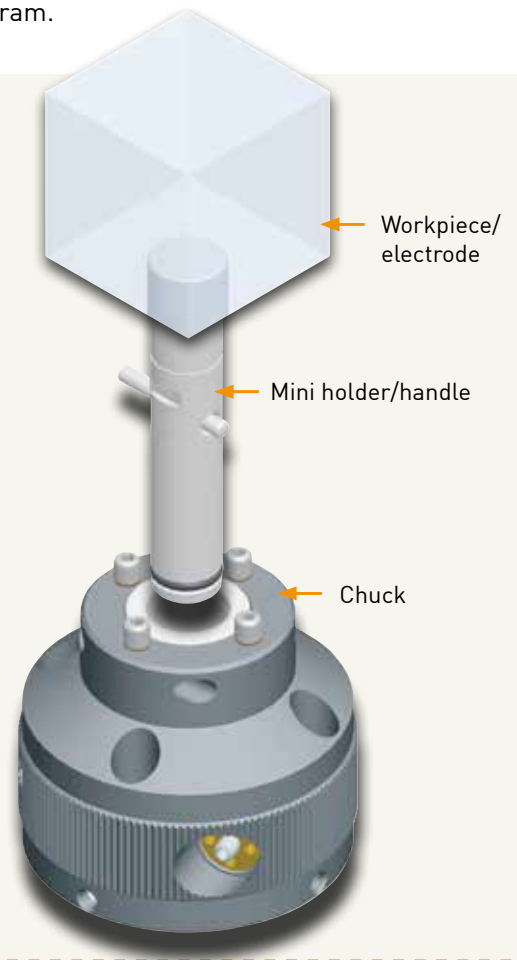

Upgrade options:

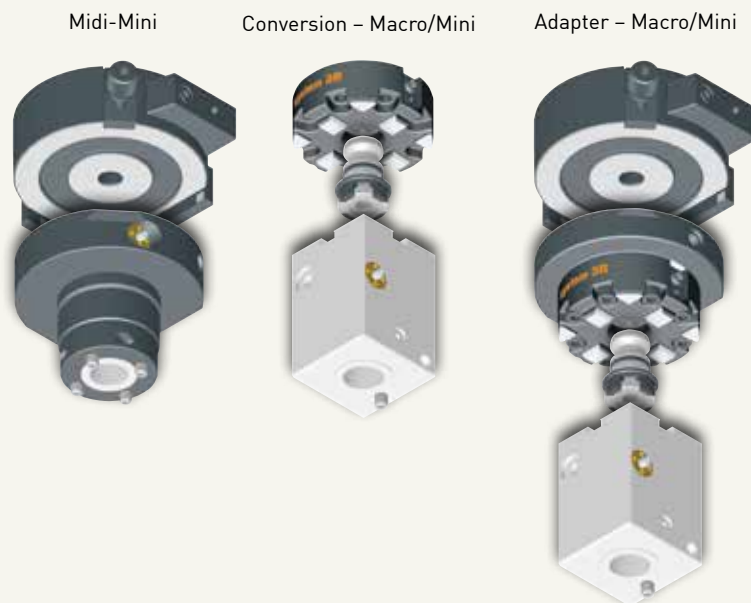

What distinguishes the original from a pirate copy:

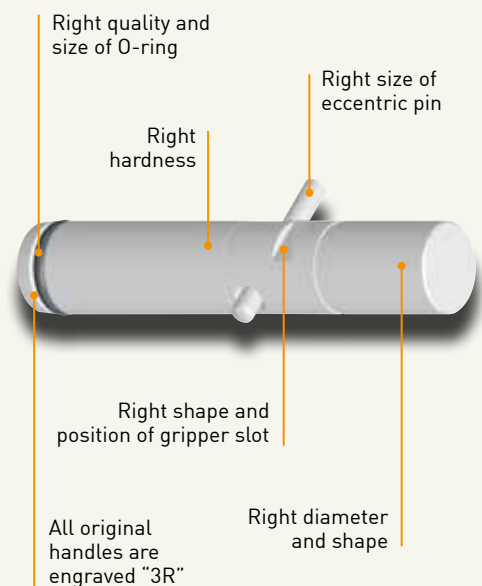

Note: Warranty undertakings only apply if genuine System 3R parts have been used.

Mini – Chucks

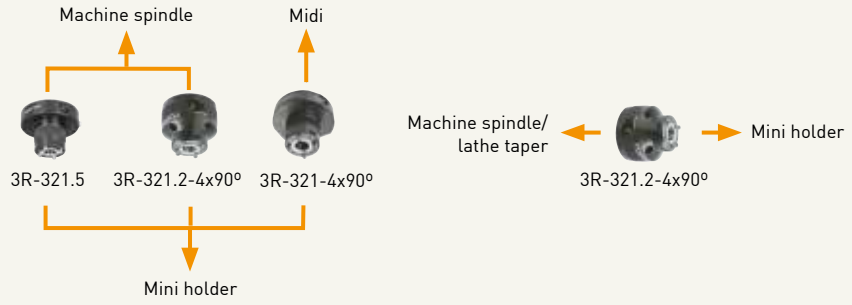

Spindle chucks	Article number	Feature
Manual	3R-321.5	Midi ► Mini
Manual	3R-321.2-4x90°	
Manual	3R-321-4x90°	

Lathe chuck	Article number	Feature
Manual	3R-321.2-4x90°	

Manual chuck, 3R-321.5

Hydraulic chuck for mounting on machine spindle with 3R-A3620.

- Fixed index positions 4x90°
- Flushing connection
- Weight 1.8 kg.

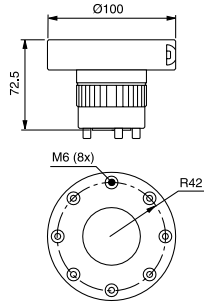

Manual chuck adapter, Midi-Mini, 3R-321-4x90°

Hydraulic chuck for mounting on machine spindle with Midi system.

- Fixed index positions 4x90°
- Flushing connection
- Weight 1.3 kg.



Manual lathe chuck, 3R-321.2-4x90°

Hydraulic chuck with set screws, for mounting on a lathe taper.

- Fixed index positions 4x90°
- Weight 1.3 kg.

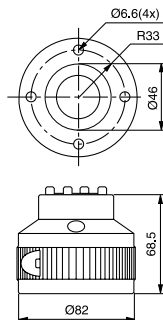

Mini – Table chucks, chuck adapters & rotating spindle

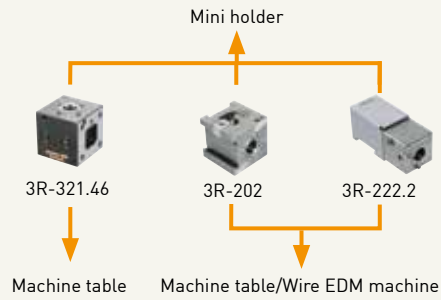
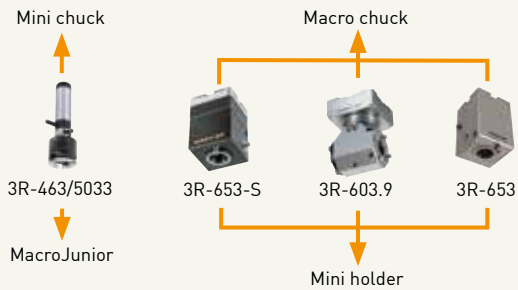

Table chucks	Article number	Feature
Manual	3R-321.46	vertical and horizontal
Manual wire EDM	3R-202	stainless steel. Vertical and horizontal
Manual wire EDM	3R-222.2	stainless steel



Chuck adapters	Article number	Feature
Manual	3R-463/5033	Mini ► MacroJunior 50 mm
Manual	3R-603.9	Macro ► Mini 90°, rust resistant
Manual	3R-653	Macro ► Mini, rust-resistant
Manual	3R-653-S	Macro ► Mini



Rotating spindle	Article number	Feature
Vertical	3R-1.321-HS	tubular electrodes

Mini – Table chucks, chuck adapters & rotating spindle

MiniBlock, 3R-321.46

Manual hydraulic chuck for vertical or horizontal mounting on the machine table.

- Fixed index positions 4x90°
- Weight 2.3 kg.

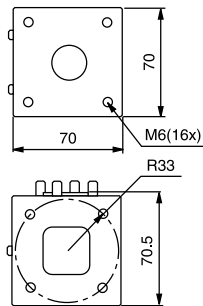

Rotating spindle, 3R-1.321-HS

Electric spindle for tubular electrodes in collets ER16.

- Supplied with collet set 3R-ER16E
- Electrode sizes $\varnothing 0.5 - 10$ mm.
- Speed range 200 – 2000 rev/min.
- Recommended maximum flushing pressure 40 bar.
- Weight 1.4 kg.

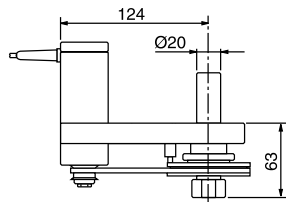

Manual chuck adapter, Mini-MacroJunior, 3R-463/5033

For mounting MacroJunior holders in the Mini system. Axial locking screw with channel for flushing through the electrode.

Note: For EDM machining only.

- Adapted for automatic changing
- Fixed index positions 3x120°
- Weight 0.8 kg.

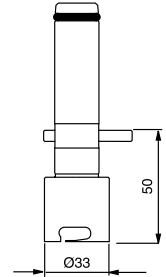

Mini – Electrode holders

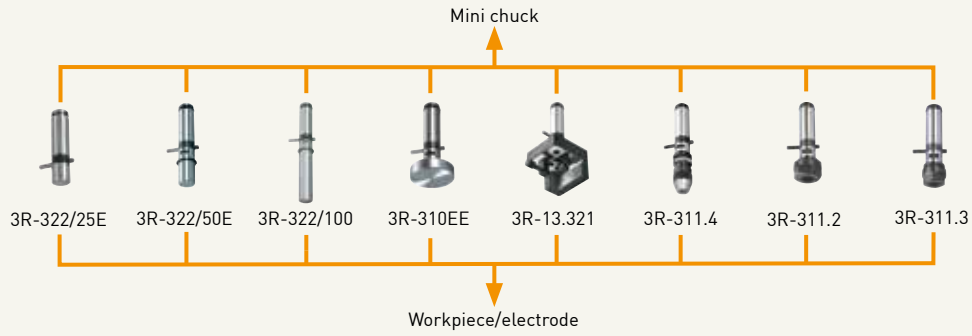

Electrode holder	Article number	Feature
Electrode holder Ø20 mm	3R-322/25E	25 mm
Electrode holder Ø20 mm	3R-322/50E	50 mm. automatic changing
Electrode holder Ø20 mm	3R-322/100	100 mm. automatic changing
Electrode holder	3R-310EE	flange Ø50 mm
Electrode holder	3R-13.321	square electrodes
Three-jaw chuck	3R-311.4	Ø0.1 - 3 mm
Collet chuck	3R-311.2	∅13 mm, ER20
Collet chuck	3R-311.3	∅10 mm, ER16

Electrode holder Ø20 mm

Holder with hardened reference part and unhardened electrode mounting part.

3R-322/25S

- Electrode mounting part 25 mm
- Flushing duct
- Supplied in sets of 30 pcs
- Weight per set 7 kg.

3R-322/50E

- Adapted for automatic changing
- Electrode mounting part 50 mm
- Flushing duct
- Supplied in sets of 30 pcs
- Weight per set 7.7 kg.

3R-322/100

- Adapted for automatic changing
- Electrode mounting part 100 mm
- Flushing duct
- Supplied in sets of 10 pcs
- Weight per set 3.8 kg.



Mini – Electrode holders & Accessories

Electrode holder, 3R-310EE

Holder with hardened reference part $\varnothing 20$ mm and unhardened flange $\varnothing 50$ mm.

- Adapted for automatic changing
- Electrode mounting part 39 mm
- Flushing duct
- Supplied in sets of 10 pcs.
- Weight per set 4 kg.

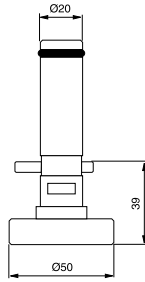

Electrode holder, 3R-13.321

Holder with hardened reference part $\varnothing 20$ mm for mounting square and flat electrodes.

- Max. workpiece: 32x28 mm
- Adapted for automatic changing
- Flushing duct
- Weight 1 kg.

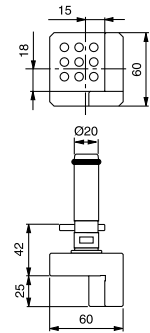

Three-jaw chuck, 3R-311.4

Chuck $\varnothing 20$ mm for $\varnothing 0.1$ -3 mm electrodes.

- Adapted for automatic changing
- Weight 0.3 kg.

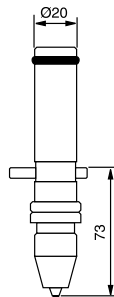

Collet chuck ER20, 3R-311.2

Chuck $\varnothing 20$ mm for collets ER20 with electrodes $< \varnothing 13$ mm.

- Adapted for automatic changing
- Weight 0.2 kg.

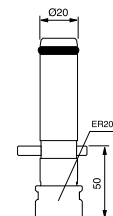

Collet chuck ER16, 3R-311.3

Chuck $\varnothing 20$ mm for collets ER16 with electrodes $< \varnothing 10$ mm.

- Adapted for automatic changing
- Weight 0.2 kg.

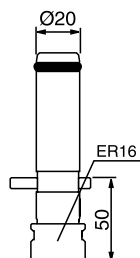

Check mandrel, 3R-23

Ground C-reference.

- Measuring length 100 mm
- Weight 0.6 kg.



Mini – Accessories

Check ruler, 3R-314.2

For setting angular positions.

- Measuring length 96 mm
- Weight 0.4 kg.



Indicating spindle, 3R-3.321-2

For measuring centre holes.

- Dial indicator required
- Weight 0.4 kg.



Microscope, 3R-4.321

With transformer (110/220V) for integral lighting.

- Magnification x25
- Centering location
- Field of view $\varnothing 6$ mm
- Weight 0.6 kg.



Clip, 3R-301

For angular fixing of Mini holders.

- Supplied in sets of 10 pcs.



Soldering kit, 3R-403

For soldering electrode blanks on Mini holders.

- Supplied with flux.



Electrode cassette, 3R-150/5

For Mini holder x30.

- Supplied in sets of 5 pcs.



Adapter plate, 3R-601.6

For mounting (for example) rotating spindles in the Macro system.

- MacroHP coupling
- Rust-resistant.

